

# **ENFORCER** **GSX** BY **CUSTOMWORKS**



Made in the USA  
by

**Custom Works RC Products, LLC**

760-B Crosspoint Drive

Denver, NC 28037

[www.CustomWorksRC.com](http://www.CustomWorksRC.com)

# **REQUIRED READING**

Thank You and Congratulations on purchasing this **ENFORCER GSX!** Within this kit you will find a race winning car with over 17 years worth of **CUSTOM WORKS** design and quality. In order for you to realize this race car's winning potential it is important to follow the written text along with the pictures included. The steps required to build this car are very easy, as long as you read before you build.

The instructional format for building this car is to open each bag in alphabetical order. Each bag of parts will be broken down into "Steps" in the manual. All parts and hardware needed to complete all steps for each separate bag, will be found in each individual bag. There is no need to steal screws from other bags. In the rare event you need to look in a different bag for a certain part, it will be noted clearly.

Considering the various dirt or clay surfaces that Nitro Dirt Oval cars are raced on today, the Enforcer GSX has been designed to be competitive on either loose packed dirt with buggy tires or high bite clay with rubber or foam racing tires. The instructions will build the kit using the most verastale set-up Custom Works has found in testing on different types of tracks, however there are various other suspension configurations available to you that you may find more suitable for your local track.

All hardware (screws, washers, nuts, etc...) are referred to by size and type in the instructions. To help clarify which screw or nut the instruction is calling for refer to the **HARDWARE REFERENCE** supplement. The size of the screw or nut should match the "shadow" of the same piece very closely.

Screw ID's are: **FH**=Flat Head **BH**=Button Head **SH**=Socket Head **SS**=Set Screw

Using some type of thread locking fluid is suggested for all parts where metal screws thread into other metal parts. We suggest using a lite setting strength thread lock for the reason you may want to take the screw out one day. Remember it only takes a very small amount to secure the screw.

Do **NOT** use power screwdrivers to drive screws into parts. The fast rotation speed can easily melt and strip plastic parts or cross-thread into the aluminum parts.

The supplied white nylon cage can be dyed in a variety of colors using basic fabric dye purchased at any fabric or craft store. Place parts in boiling water with dye stirred within until parts are desired color.

Lightly sand the edges of the graphite pieces using a medium grade sandpaper to avoid splinters. Run a thin bead of Super Glue around the edges to give pieces greater durability.

# **SUGGESTED TOOLS**

Medium Sandpaper

Hobby Scissors

Small Needle Nose Pliers

Wire Cutters

.110" Drill Bit

X-Acto Knife

Phillips Head Screw Driver

Blue Loctite

3/16" Drill Bit

3/16" Wrench

# Bag A

## Front Suspension

**Step #1:** Begin by checking the fit of the Suspension Pin in the Suspension Mounts. The Suspension Mounts are machined to a VERY close tolerance and may be tight on the pin at first. If it is tight, slide the pin in and out to clear any burrs that may remain. After checking that the Suspension Pin spins freely in all four holes, slide (1) #4233 Suspension Pin thru the front of the #3250 Suspension Arm and thru the lower hole on the #2204 Suspension Mount as shown in **Figure #1**.

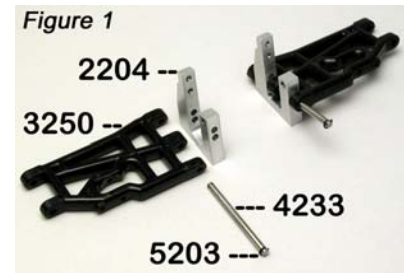

**Step #2:** Repeat Step #1 with #3250 Suspension Arm facing opposite direction from Suspension Mount. This will make a Left and Right side front suspension for the car.

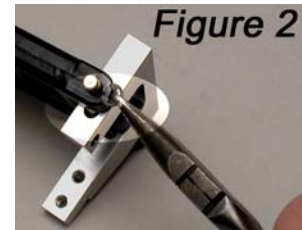

**NOTE:** Stepped side of Suspension Arm faces the front of the car.

**Step #3:** Add one #5203 E-clip to each end of the Suspension Pins as shown in **Figure #2**.

**Step #4:** Attach Suspension Mounts to the #1201 Enforcer GSX Chassis with (4) 3/8" FH Screws in the right-most set of holes as viewed from the front of the chassis like in **Figure #3**.

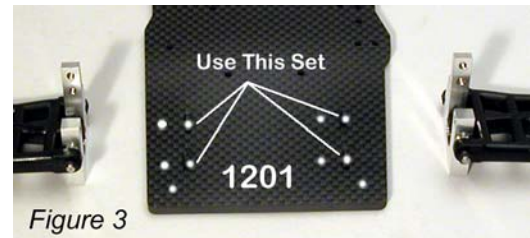

**Step #5:** Locate the Hood Mount from the Lexan Body Bag and trim the Hood Mount on the molded line. Position the Hood Mount even with the front of the chassis as shown in **Figure #4a**. With a Sharpie Marker, place a dot where the hole from the Suspension Mount is located on the Hood Mount. As shown in **Figure #4b**, do this to both sides of the Hood Mount. This is to mark the spot where the #2210 Front Mount Brace will go thru the Hood Mount.

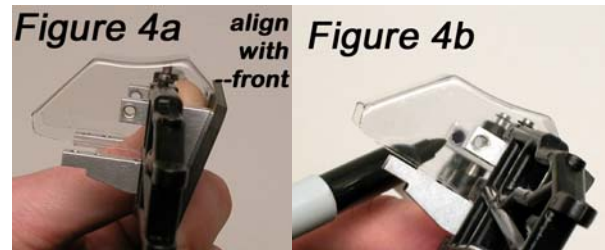

**Step #6:** With a 3/16" Drill Bit make a hole through both marks you made on the Hood Mount in Step #5. Slide the #2211 Suspension Mount Brace thru the drilled holes in the Hood Mount. Attach the Suspension Mount Brace with (2) 1/2" BH screws to the Suspension Mount as shown in **Figure #5**.

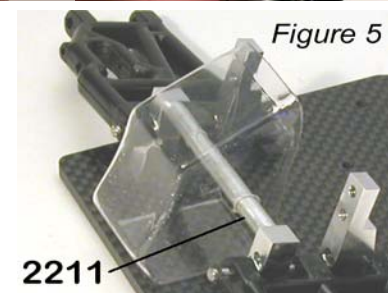

**Step #7:** Attach the #1242 Front Shock Tower to the Suspension Mounts with (2) 1/4" BH Screws in the bottom right-most set of holes as viewed from the front of the chassis like in **Figure #6**.

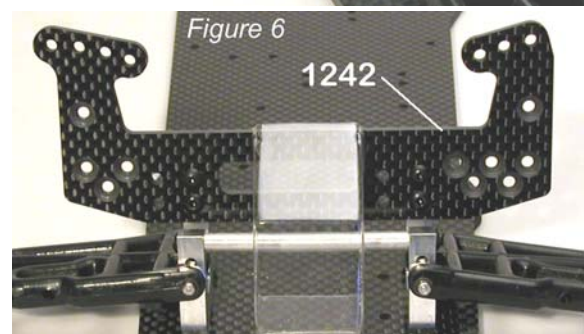

# Bag B

## Castor Blocks / Suspension Tie-Rods

For **Step #1** thru **Step #7** you will be building both Right and Left steering assemblies.

**Step #1:** Press the #7201 Front Axle into the #3202 Steering Block. Align holes in both parts as shown in **Figure #7** so that they will allow #7202 King Pin to slide thru in the next step.

**Step #2:** Place the Steering Block with Front Axle into #3203 Castor Block as shown in **Figure #8**. Slide the King Pin thru the #3203 Castor Block and Steering Block. Attach an e-clip to each end of the King Pin.

**Step #3:** Thread one 6/32 x 1/8" set screw into the back of the #7201 Front Axle as shown in **Figure #9**.

You should now have a Right and Left Steering Assembly as shown in **Figure #10**.

**Step #4:** Press the Pivot Ball into the #5228 Ball End, then thread the Ball Ends onto each end of the #5222 Turnbuckle. When completed it should look like the Camber Links in **Figure #11**.

**NOTE:** The Turnbuckles have *normal* threads on one side of the turnbuckle, and *reverse* threads on the other. Mark the Ball End with the NORMAL threads so you remember which way to turn the Turnbuckle for adjusting the Camber Link with supplied tie-rod wrench.

**Step #5:** Attach the Camber Link by sliding a 1/2" BH Screw thru the Ball End and thread it into the top of the Castor Block as shown in **Figure #12**.

**Step #6:** Mount the Steering Assembly to the Suspension Arm by sliding #4237 Outer Suspension Pin thru the Suspension Arm and Castor Block. Add one e-clip to each end of the pin as shown in **Figure #13**.



Figure 7



Figure 8



Figure 9

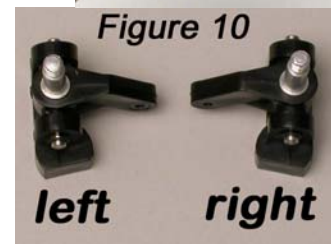

Figure 10



Figure 11

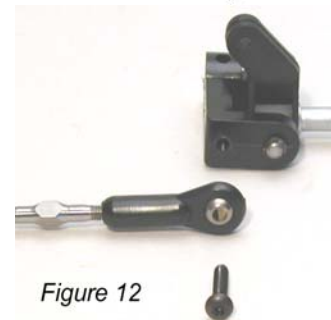

Figure 12

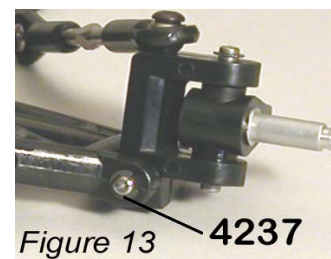
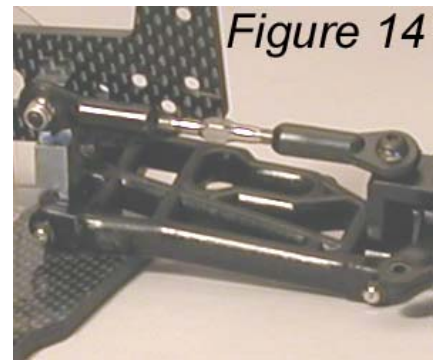

Figure 13

**Step #7:** Thread one 4-40 X 5/8" BH Screw thru the front of the Shock Tower in remaining upper holes that mount the Shock Tower to the Suspension Mounts. On the backside of the Suspension Mount, slide the Ball End from the Camber Link onto the 5/8" BH Screw and fasten to the car with (1) 4-40 Lock Nut. The finished assembly should look like that in **Figure #14**.



## Bag C

### Steering Assembly

**Step #1:** Press the Pivot Balls into the #5214 Ball End, then thread the Ball Ends onto each end of the #5221 Turnbuckles. When completed it should look like the Steering Links in **Figure #15**. Make 2 of these.

**Step #2:** Assemble the Steering Links on each end of the #3207 Steering Rack Slide using (1) 3/8" 2-56 SH Screw with (1) #2 Washer between the screw head and Ball End. Insert (1) 2-56 Locknut into the hexagon hole on the backside of the Steering Rack Slide and tighten the 3/8" 2-56 SH Screw to it. Refer to **Figure #15** for example.



**Step #3:** On the remaining turnbuckle thread (1) #5228 ball end and (1) #5229 ball end, these are the two shortest ends in the bag. Now install the Servo Linkage to the raised hole on the #3207 Steering Rack Slide using (1) 1/2" 2-56 SH Screw with (1) #2 Washer on each side of the Ball End. Insert (1) 2-56 Locknut into the hexagon hole on the backside of the #3207 Steering Rack Slide and tighten the 1/2" 2-56 SH Screw to it. Refer to **Figure #15** for example.

**Step #4:** Install the Steering Rack Slide into the Steering Rack with the raised hole on the Steering Rack Slide to the RIGHT. The Steering Rack Slide should move FREELY in the Rack. If it does not, check for flashing on the slide OR pry open the Rack with your fingers. You should now have the Steering Assembly built as seen in **Figure #16**.



**NOTE:** You will need to adjust the length of all of these rods after the car is completely assembled and your radio is installed.

**Step #5:** Mount the now completed Steering Assembly to the chassis using (2) 3/8" FH Screws.

**Step #6:** Mount the Steering Links to each Steering Block using (1) 3/4" 2-56 SH Screw with (1) # 5232 Coned Spacer between the pivot ball and steering arm. The cone faces up toward the pivot ball as shown in **Figure #17**. Fasten the 2-56 screw to the steering arm with (1) #2 Washer and (1) 2-56 Lock Nut.



## Bag D Rear Suspension Arms and Shock Tower

**Step #1:** Remove flashing and burrs from the #3240 Suspension Arms then attach to the #2222 Toe-Block with a #4234 1/8" X 7/8" Suspension Pin as shown in **Figure #18**. Add one #5230 1/8" E-Clip to each end of the Suspension Pin. This clip is slightly LARGER than the clips used so far in the kit.

**Step #2:** In the rear of the chassis, insert the (3) 1/2" FH Screws thru *outer* most set of holes on the LEFT side of the chassis. Now insert the other (3) 1/2" FH Screws thru the *middle* set of holes on the RIGHT side of the chassis. Place (1) #1248 Toe Block Spacer over both sets of screws in the rear of the chassis as shown in **Figure #19**.

**Step #3:** Mount the #2222 Toe Blocks to the chassis by aligning the *rear* 1/2" FH Screw passing thru the chassis with the threaded hole closest to the (3) Dimples on the Toe Block. By mounting the screw in the hole with the (3) Dimples next to it, you are mounting the Toe Blocks on the car so that the rear wheel will have 3 Deg of Toe-In. If the screw were to thread into the hole with the (1) Dimple next to it, the rear wheel would have 1 Deg of Toe-In. Refer to **Figure #20** for example or mounting options. Continue to fasten the other screws.

**Step #4:** Attach the #2224 Top Plate Block and (2) #3263 Shock Tower Stand-Offs to the #1243 Rear Shock Tower using (6) 3/8" BH Screws as shown in **Figure #21**.

**Step #5:** Attach the (2) #2218 Camber Link Stand-Offs to the same side of the #1243 Shock Tower as the blocks from the previous step using (2) 3/8" BH Screws. Mount the Camber Link Stand-Off in the middle position of the upper row of holes as shown in **Figure #22**.

**Step #6:** Mount the Rear Shock Tower assembly to the rear of the chassis using (4) 3/8" FH Screws. When completed your car should look like the one in **Figure #23**.



Figure 18

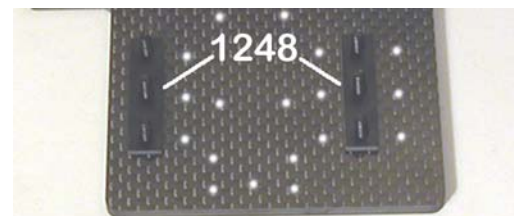

Figure 19

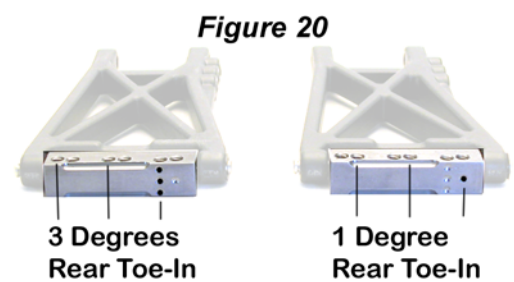

Figure 20

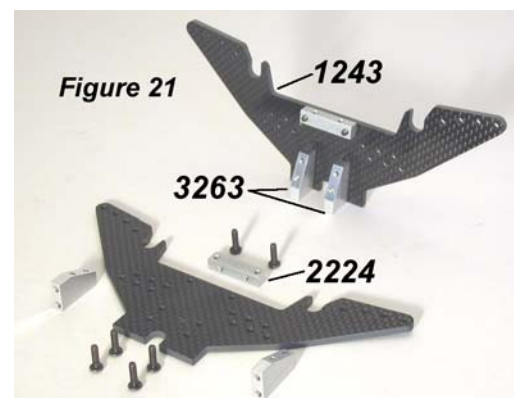

Figure 21

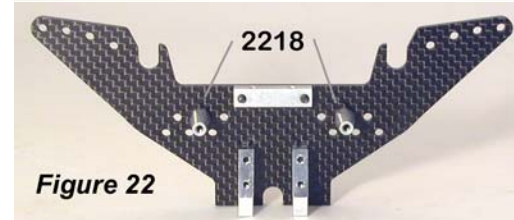

Figure 22



Figure #23

# Bag E

## Bearing Carriers/Camber Links/Drive Train

**Step #1:** Open the bag containing the #7210 CVD's and build them according to the instructions.

**NOTE:** Save the extra axle shims included in the bag, they will be used in Step #2

**Step #2:** Press (2) #1226 3/16"X 3/8" Unflanged Bearing into each side of the #3241 Bearing Carrier. Following the sequence of part in **Figure #24**, first slide (2) of the THIN axle shims that were packaged in the #7212 "CVD Bag". Now slide the CVD Axle thru the bearings in the carrier. Finish this step by sliding (1) THICK Shim from the "CVD Bag" onto the axle. Make (2) of these.



**Step #3:** To secure the axle, press the #7204 Roll Pin into the hole in the axle that is close to the outer bearing in the #3241 Bearing Carrier. Although it can be difficult at times, the best way we have found to do this is to get the Roll Pin into position directly over the hole by holding in the entire piece as shown in **Figure #25**. With the piece on its side and the roll pin in position, use the pliers to squeeze the Roll Pin into the axle. When complete, equal parts of the Roll Pin should be on both sides of the axle. Make (2) of these.



**Step #4:** Partially slide (1) #4235 Suspension Pin thru the remaining holes in the end of the Suspension Arm. Add (2) #4236 Rear Carrier Shims to the Suspension Pin then slide the Suspension Pin thru the BOTTOM holes on the Bearing Carrier. After the pin is thru the Bearing Carrier place (2) more Rear Carrier Shims between the Bearing Carrier and the Suspension Arm. To finish assembly add (1) #5230 E-Clip to each end of the Suspension Pin. There should now be 2 Shims on each side of the Bearing Carrier as shown in **Figure #26**. Do this step to both sides of the car.

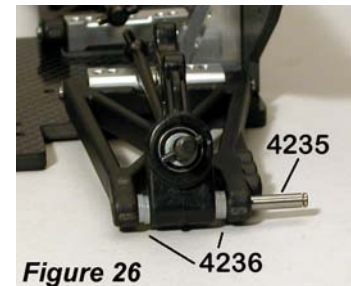

**NOTE:** There are extra .010" thick Shims enclosed, these are to be used if the Rear Carrier Shim does not take out all of the play. You want the Bearing Carrier to be free as it pivots on the pin, but not slide forward/backward on it excessively. Also the Bearing Carriers can fit on either side of the car; there is no RIGHT or LEFT side to this part.

**Step #5:** Press the Pivot Ball into the Ball End, then thread the #5213 Ball Ends onto each end of the #5223 Turnbuckles. When completed it should look like the Camber Links in **Figure #27**. Make 2 of these.

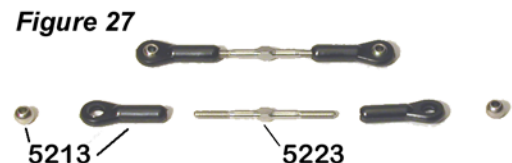

**Step #6:** Attach one end of the Camber Link to the Aluminum Stand-Off already assembled on the Shock Tower with (1) 3/8" BH Screw. Attach the other end of the Camber Link with (1) 1/2" BH Screw to the FRONT of the Bearing Carrier and thru the OUTER-MOST hole. Tighten (1) 4-40 Locknut to the Screw on the back side of the Bearing Carrier as shown in **Figure #28**.

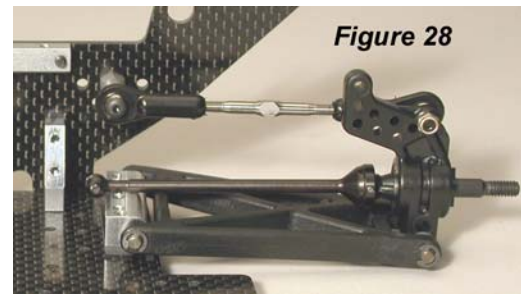

## Bag F

### Differential Assembly

**Step #1:** Apply a generous amount of #4391 Diff Lube into the diff ball holes on the #4407 Diff Gear. With Diff Lube in holes, press the (12) #4357 Diff Balls into the holes on the Diff Gear. Be sure to spread out the grease that was pushed out when installing the Diff Balls. Finally press (1) #1229, 5/32" X 5/16" Bearing into the center of the Diff Gear as shown in **Figure #29**.

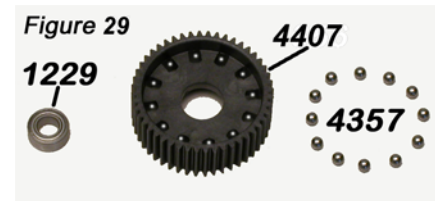

**Step #2:** Using the #4402 Left Diff Outdrive Hub, press the #4362 Diff Spring into the slotted end of the Diff Hub followed by the #4361 T-Nut as shown in **Figure #30**.



**Step #3:** Following along with **Figure #31**, slide (1) #4360 Diff Thrust Washer onto the #4361 2-56 Diff Bolt. Apply a good amount of #4388 Black Grease to the Thrust Washer on the side facing away from the bolt head. Now stick (6) #4359 Diff Thrust Balls into the Black Grease on the Thrust Washer. Slide the remaining Thrust Washer onto the Diff Bolt. There should be enough Black Grease to hold the Thrust Balls in place during assembly. Now carefully slide the entire Bolt into the outdrive end of the #4403 Right Diff Outdrive Hub without losing any Thrust Balls. Finally insert the Bolt Cover.

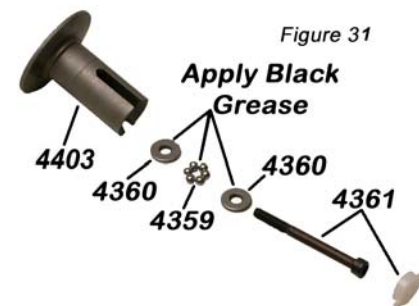

**Step #4:** Insert (1) #1229, 5/32" X 5/16" Bearing into the Right Outdrive Hub. Apply a very thin coat of Diff Grease to the flat area on BOTH the Right AND Left Outdrive Hubs as shown in **Figure #32**. Now place (1) #4404 Diff Drive Ring on both areas with the thin coat of Diff Lube. Slide the Diff Gear onto the Right Outdrive Hub. Finally slide the Left Outdrive Hub over the Diff Bolt and onto the Diff Gear. Tighten the Diff Bolt to the T-Nut but not all the way. Check to make sure the Diff Plates are still in their seat on the Outdrive Hubs and rotate the Diff Hub several times as you tighten the bolt. Follow Step #5 for instruction on how to finish tightening the Diff Bolt.

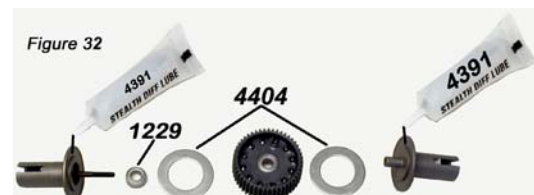

**Step #5:** As shown in **Figure 33**, place the 1/16" wrench used earlier through the slot in the opposite Diff Outdrive. As you tighten the Diff Bolt, you should notice the T-Nut stubs moving closer to the end of the Diff Hub slot. While the T-Nut is moving closer to the end of the slot, the spring behind the T-Nut is being compressed. When the T-Nut reaches the bottom of the slot, the spring should be fully compressed. Pay attention to feeling when the spring is fully compressed, you **DO NOT WANT TO OVERTIGHTEN THE BOLT**. When the spring is fully compressed, loosen the Diff Bolt 1/8 of a turn, No more or less. Your Diff should spin smoothly with the hubs turning in opposite directions.

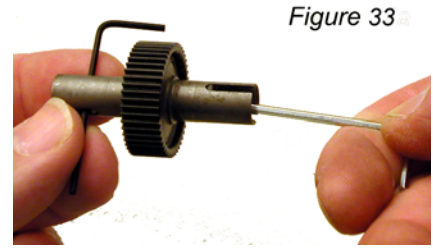

Figure 33

**NOTE:** After running the car once or twice, check the adjustment of the Diff.

## Bag G

### Transmission Casing

Follow Figure #34 for Steps #1 thru #3

**Step #1:** Separate the #4401 Transmission Halves from the each other, and insert (2) #1226, 3/16" X 3/8" Bearings into the top two holes of each case and (1) #1230, 3/8" X 5/8" Bearing to the bottom of each case.

**Step #2:** Slide (1) THICK Washer over the longer part of the #4368 Top Drive Shaft and insert the long side thru the top bearing in the Right Side Transmission Half. Now place the #4405 Idler Gear into the middle bearing and the Right Side Diff Hub (Hub with Diff Bolt) into the lower bearing on the Right Side Transmission Half.

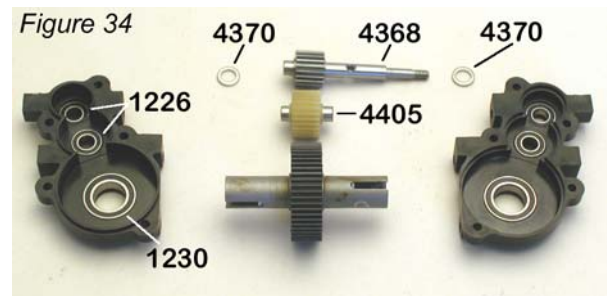

Figure 34

**Step #3:** Place (1) THICK Washer over the short shaft of the Top Drive Shaft and align the Left Side Transmission Half over all 3 gears.

**Step #4:** Install (5) 3/8" SH Screws into the Left Side Transmission Half and tighten them into the Right Side Transmission Half. Press the #4406 Roll Pin into the hole in the Top Gear Shaft so that equal parts of the Roll Pin stick out of the shaft, just as when installing the Roll Pins on the CVD axles. Refer to **Figure #35** for example.

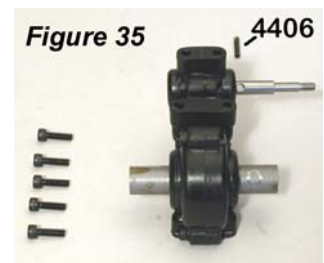
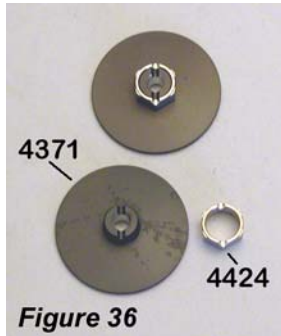

Figure 35

## Bag H

### Slipper-Clutch Assembly

**Step #1:** Press the #4424 Brake Adapter onto the #4371 Inner Clutch Hub with the notches lining up as shown in **Figure #36**. It will fit VERY tight and may need to be tapped lightly to fit into place.



**Step #2:** Slide the #4423 Brake Disc onto the Brake Adapter. The finished piece should look like **Figure #37**.

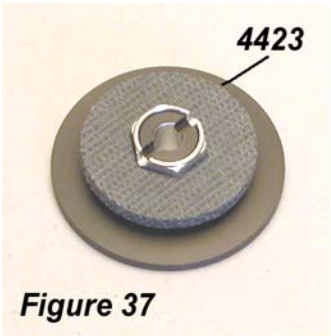

Follow the parts as they are laid out in sequence in **Figure #38** for **Step #3 thru Step #7**.

**Step #3:** Slide the #4371 Inner Clutch Hub onto the Top Drive Shaft and align the slot over the Roll Pin.

**Step #4:** Place the #4373 Clutch Disc onto the Inner Clutch Hub with the #4372 Outer Clutch Hub on top.

**Step #5:** Install (1) #4376, 3/16" X 3/8" Bushing on the shaft followed by (1) Silver Washer, (1) Thick Gold Washer, and (1) Silver Washer (#4375).

**Step #6:** Slide on #4374 Torque Control Spring and secure all of the above with (1) #5245 5-40 Lock-nut until the top of the nut is flush with the end of the Top Drive Shaft.

**Step #7:** Attach the #4960 Spur Gear with (2) #5250 3/16" BH Screws with the flat side facing out.



## Bag I

### Brake Assembly

**Step #1:** Following **Figure #39**, slide the #4421 Brake Shoe onto the #4420 Brake Bracket with both crescent shape cut-outs facing the same direction.

**Step #2:** Install the Brake Bracket with Shoe to the Transmission as shown in **Figure #40** so that the Brake Disc is between the Bracket and the Shoe. Secure the top of the Brake Bracket to the Transmission using (2) 1/4" BH Screws.

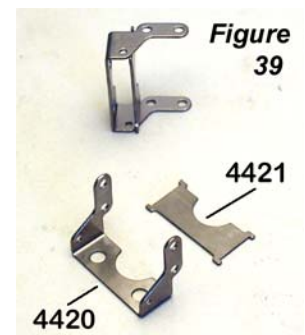

**Step #3:** Slide the #4422 Brake Cam thru the small holes remaining in the Brake Bracket. The lever of the Brake Cam should be facing the same direction as shown in **Figure #41**.

**Step #4:** Press the #4425 Brake Cam Clip over the end of the Brake Cam in the location shown in **Figure #42**. Make sure the cone of the clip faces away from the Brake Bracket. We have found it easiest to press the Clip on the Brake Cam using a 3/16" socket.

**NOTE:** It is possible to mount the entire brake assembly so it faces toward the rear of the car allowing the motor to mount closer to the gearbox. However you must run a small enough spur gear so that the #4422 Brake Cam does not swing INTO the spur gear.



Figure 41

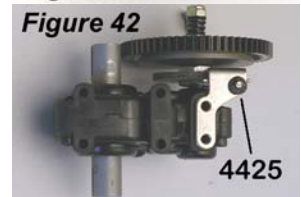

Figure 42



Figure 43

## Bag J Mounting Transmission

**Step #1:** Using the Black Grease used to build the Diff, place a small amount on both Dog-Bone Pins as shown in **Figure #43**.

**Step #2:** Following **Figure #44**, bring the Transmission in from the FRONT of the car, place each Dog-Bone into the Outdrive Hub and set the Transmission on top of the #1202 Transmission Spacer. Secure the Transmission to the Chassis using (4) 1/2" FH Screws that pass thru the bottom of the Chassis and the Spacer, threading into the Transmission.

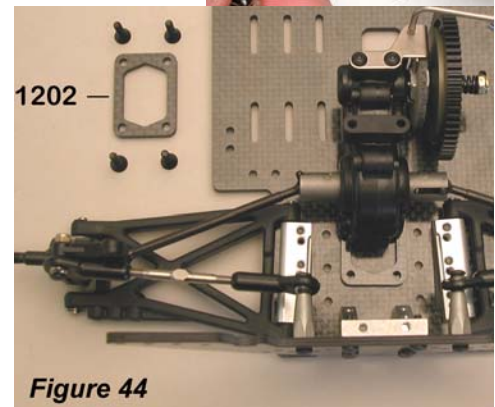

Figure 44

**Step #3:** Slide the #3265 Transmission Foot shown in **Figure #45** underneath the front on the Transmission. Slide (2) 1" FH Screws thru the bottom of the chassis and thru the Foot threading the screws into the Transmission.



Figure 45

**Step #4:** Mount the #1244 Transmission Brace to the top of the Transmission as shown in **Figure #46** using (2) 3/8" BH screws.

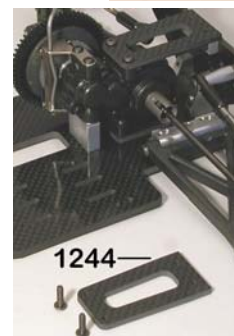

Figure 46

**Step #5:** Locate the Tail Tank Mount in the Lexan Body Bag and drill (2) .110" holes on the "dimples" molded in the Mount. Secure the Mount to the rear of the Transmission Brace using (2) 3/8" BH Screws with a Washer on each as shown in **Figure #47**.

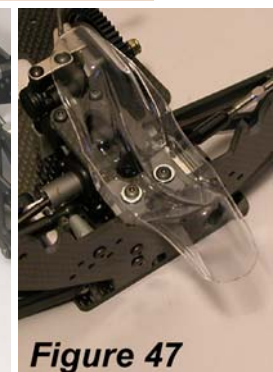

Figure 47

# Bag K

## Mounting and Building Shocks

For **Step #1 thru Step #5** , complete each task **(4) Times**.

**Step #1:** Mount (1) #1403 Black O-ring into the groove on the #1402 Threaded Shock Collar as shown in **Figure #48**. Add a drop of Shock Oil to the O-ring and thread it onto the #1401 Threaded Shock Body with the “shoulder” facing down.



**Step #2:** Soak the #1411 VC Foam with the Shock Oil and install it onto the VC Bobbin as shown in **Figure #49**.

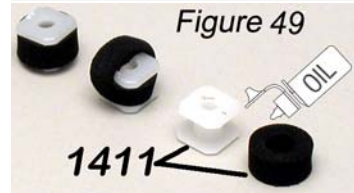

**Step #3:** Remove the #1405 Shock Pistons with the “2” on them from the parts tree as shown in **Figure #50**. Be SURE to REMOVE ANY BURRS on the Shock Piston, or your shock will NOT work correctly. Add a #5230 E-Clip to each side of the #2 Shock Piston on the #1413 Shock Shaft. Install (1) #1406 O-ring over the threads on the TOP of the Shock Body. Both of these are shown in **Figure #51**.

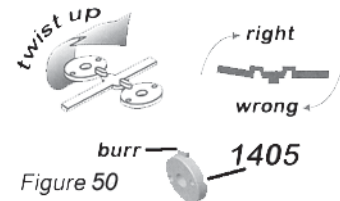

**Step #4:** Following the sequence of parts in **Figure #52**, slide the VC Bobbin from Step #2 on the Shock Shaft and then (2) #1250 O-Rings. Add a couple drops of oil to the O-Rings and insert the entire Shock Assembly into the Shock Body and FIRMLY pull the Shock Shaft through in order to “seat” the VC Bobbin. Finally press the #1409 Pivot Ball into the Eyelet and thread it onto the Shock Shaft. Be sure when holding the Shock Shaft with pliers to use a rag to cover the shaft so the pliers don’t scar it.



**Step #5:** Follow **Figure #53** to fill the shocks with oil.

**Figure 53**

- 1** Holding the shock upright, fill with oil to the top of the body.
- 2** Slowly move the shaft up and down several times to allow air bubbles to escape to the top.
- 3** Refill with oil to the top of the body.
- 4** Push the shaft up until the piston is level with the top of the body. The oil will bulge up above the shock body.
- 5** Fill the #6428 shock cap about halfway with oil and install onto the body. Try to retain as much oil as possible during assembly. The shaft will extend out as you tighten the cap down.

**Setting the Rebound**

- 6** Move the shock shaft in and out a few times and then push it all the way in. It should be easy to push the shaft in until the eyelet hits the body.
- 7** Then the shaft should push itself out to its full length very slowly.
- 8** If the shock does not push out this far there is not enough oil in it. Add just a little oil and try steps 6-7 again.
- 9** If the shock rebounds too fast, or you cannot push the shaft in until the eyelet hits the body, there is too much oil. Loosen the cap about a full turn and pump out a small amount of oil by pushing the shaft in. Retighten the cap and try steps 6-7 again.

Figure 53 is a large diagram showing the steps for filling and setting the shock. It includes illustrations of the shock being filled with oil, the shaft being moved up and down, the shaft being pushed up to the top, the shock cap being installed, and the shock being tested for rebound. Arrows indicate the direction of movement for the shaft and the shock cap.

**Step #6:** Using #1442 Silver Springs on the Rear and #1444 Gold Springs on the Front, slide the spring over the shock shaft and onto the shock body. Compress the spring and then add the #1407 Spring cup by sliding it on the shaft through the notch in the spring cup. The cup should then slide down over the shock eyelet until it bottoms out. Release the spring and your shock should now look like the one at the top of **Figure 54**.



**Step #7:** On the Rear Shock Tower, Insert (1) 4-40x7/8" SH Screw thru the inner hole on each side of the Shock Tower as shown in **Figure #55**. Thread on (1) #2214 Shock Stand-Off onto each screw with the shoulder on the spacer facing AWAY from the Shock Tower.

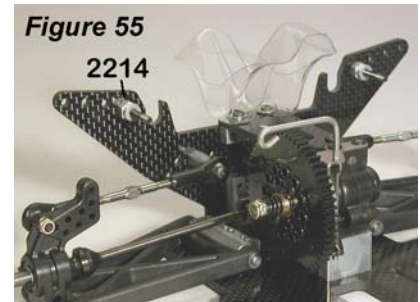

**Step #8:** On the Front Shock Tower, Insert (1) 4-40x7/8" SH Screw thru the inner hole on each side of the Shock Tower as shown in **Figure #56**. Thread on (1) #2214 Shock Stand-Off onto each screw with the shoulder on the spacer facing AWAY from the Shock Tower.

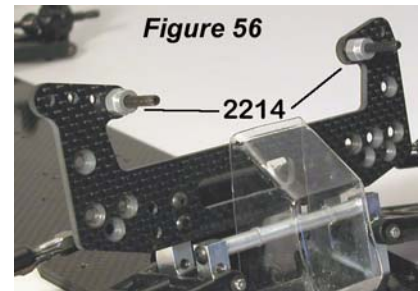

**Step #9:** Mount the Rear Shocks by placing the Shock Cap End of the shock onto the mount on the Shock Tower. Insert (1) #1408 Shock Bushing on the mount and into the Shock Cap and fasten with (1) 4-40 Lock-nut as shown in **Figure #57**. Following **Figure #58** mount the Eyelet end of the Shock with (1) 1/2" SH Screw and (1) #5212 Washer to the INNER most hole on the Suspension Arm.

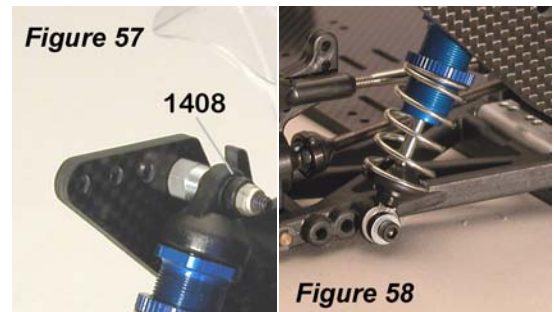

**Step #10:** Mount the Front Shocks by placing the Shock Cap End of the shock onto the mount on the Shock Tower. Insert (1) #1408 Shock Bushing on the mount and into the Shock Cap and fasten with (1) Lock Nut as shown in **Figure #59**. Mount the Eyelet end of the Shock in between the supports in the Suspension Arm with (1) 5/8" SH Screw.



## Bag L

### Fuel Tank / Motor Mounts

**Step #1:** Slide (3) 3/8" FH Screws thru the bottom of the chassis in the locations shown in **Figure #60**. There are two sets of holes for the fuel tank in the chassis, place the screws in the holes closest to the front of the car. Slide (1) O-ring over each of the 3 screws and thread the screws into the #4450 Fuel Tank so that the tank barely snugs the O-rings. If you overtighten the screws the O-rings will not dampen the vibrations from the motor as effectively.

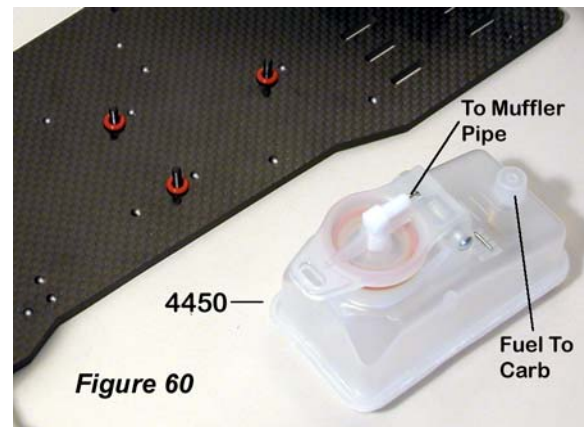

**Step #2:** Using (4) M3x8mm Screws place (1) Washer on each screw and slide it thru the slots in the chassis as shown in **Figure #61**. Attach the (2) #3270 Nitro Motor Mounts with the tapered side facing toward the right side of the car.

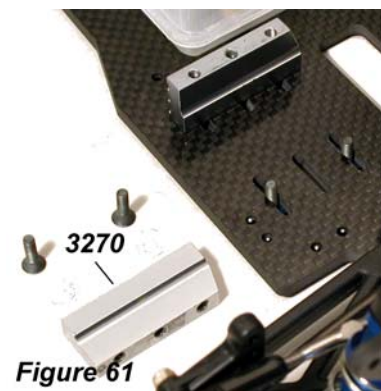

**Note:** If you already have your radio and electronic equipment you may proceed to Bag "M". If you wish to install it at a later point than proceed to Bag "N". In our experience, radio installation is much easier without the cage and body attached.

## Bag M

### Servo and Linkage Installation

The following steps will guide you through the process of installing your radio equipment. While the installation we show will provide the most versatile use of your new GSX ENFORCER it is important to understand that radio equipment comes in a variety of shapes and sizes. Always follow the recommendations of your radio or electronic equipments manufacturer regarding their use and operation. For alternate installations consult your hobby dealer or you can find more information on our website.

**STEP #1:** Using the (4) 3/8" FH screws and (4) washers, mount the servo to the #5240 Servo Mounts being sure to place the open slots of the mounts toward the bottom of the servo. Also the additional mounts on the side of the Servo Mounts must face toward the bottom of the picture with the servo positioned as shown in **Figure #62**. Do this step to both servos to be used in the car.



**STEP #2:** Slide (1) 1/2" SH Screw thru the back of the #5242 Servo Saver in the largest hole available. Now slide (1) Washer and the Ball End from the Steering Link already mounted to the Steering Rack on the car over the screw in the Servo Saver and secure with (1) Lock Nut as shown in **Figure #63**.

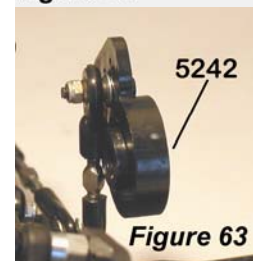

**STEP #3:** Remove the Servo Saver Spline adapters from Bag M along with the #5242 Servo Saver. Determine which of the 3 Spline Adapters fits your particular brand of servo by sliding it over the spline on top of the servo. Now align your Servo Saver over the spline so that the servo will have equal amounts of travel when mounted as shown in **Figure #64**.

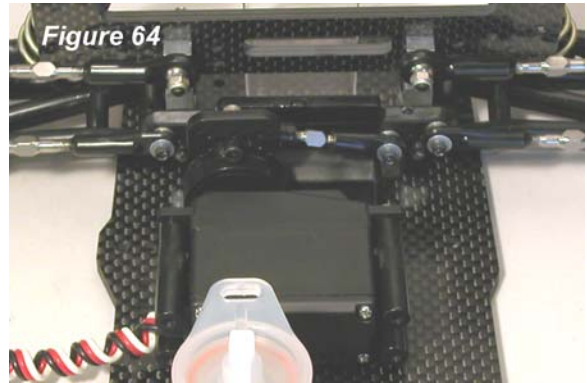

**STEP #4:** Mount the steering servo to the car using (2) 3/8" FH Screws. Following **Figure #64** note when the Servo Saver is facing straight up the Slide in the Steering Rack is centered in the car. Adjust the link from the Servo Saver to the link to correct this. Mount the throttle servo to the car using (4) 3/8" Screws with the servo spline facing the front of the car as shown in **Figure #65**.



**STEP #5:** Now thread your antenna wire through the base of the antenna mount and then through the antenna tube as shown in **Figure #66**. Secure the antenna mount to the chassis with (1) 1/4" FH Screw through the hole at the right rear of the steering servo. Use double sided tape and mount your receiver to the top of the steering servo.

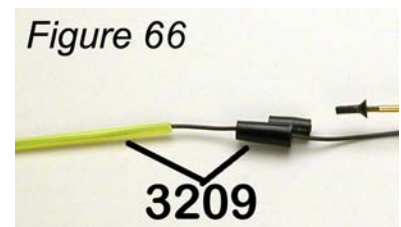

**STEP #6:** Following **Figure #67**, mount the #5246 Servo Horn Adapter to the servo horn that came with your radio using the (2) Small Self-Tapping Screws.

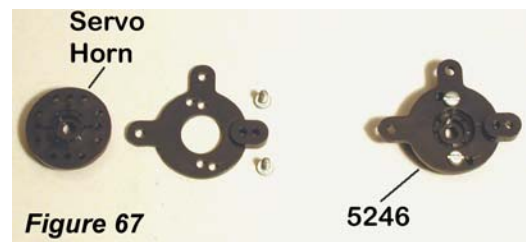

**STEP #7:** Take (1) of the 5246 Threaded Rods and cut off half of BOTH the threaded and smooth rod areas. This will leave the "threaded" end roughly 3/8" long and the "smooth" end of the rod approximately 2" long. Thread the white Ball Cup onto the rod and slide on (1) Brass Collar, (1) Aluminum Pivot, and lastly (1) more Brass Collar as shown in **Figure #68**. Mount the Aluminum Pivot to the Adapter using (1) Retainer Clip.

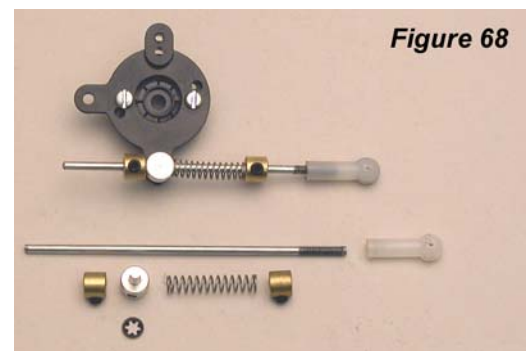

**NOTE:** For illustrative purposes the motor has been placed in the car. You will want to mount the motor when you have the clutch bell assembly attached.

**STEP #8:** Now take the other Threaded Rod and thread on the Black Ball Cup roughly half way. Place (1) Collar then (1) Small Washer onto the rod and leave roughly 1 11/16" distance between the end of the threads and the collar. Now slide the open end of the rod thru the front of the Brake Cam and place (1) Small Washer, (1) Small Spring, and finally (1) Collar so it all fits together as shown in **Figure #69**. Align the servo horn on the splines in the same fashion as you did the servo saver for the steering rack, so that you have equal throw in both directions. Finally mount the servo horn with the original screw that came with your servo. With the Throttle Servo positioned as you see in **Figure #69**, there should be a slight bit of resistance when you try and spin the spur gear.

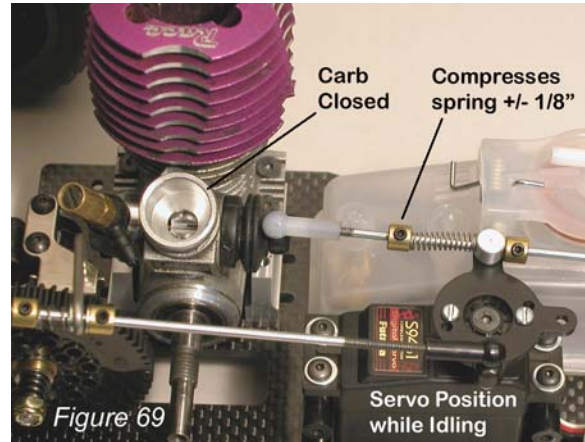

**STEP #9:** Snap the white ball cup onto the ball stud on your carb. Keeping the servo positioned as shown in **Figure #69**, loosen the collar on the right side of the Pivot and slide the rod so that the carb can fully close with the throttle in the neutral position. Next slide the right side collar up against the Pivot and tighten. Lastly adjust the left side collar so that it compresses the spring 1/8" to 3/16".

**STEP #9:** Within your radio locate the End Point Adjustments (EPA) setting. Here you will reduce the amount of travel your servo has so that you do not damage your carb. You only want the servo to pull the carb slide only as far as the slide will go. If you do not set the end point the servo will pull too far on the carb and certainly will damage it. Notice the carb position in **Figure #70**, this is full throttle to the motor and the servo should pull no further than this.

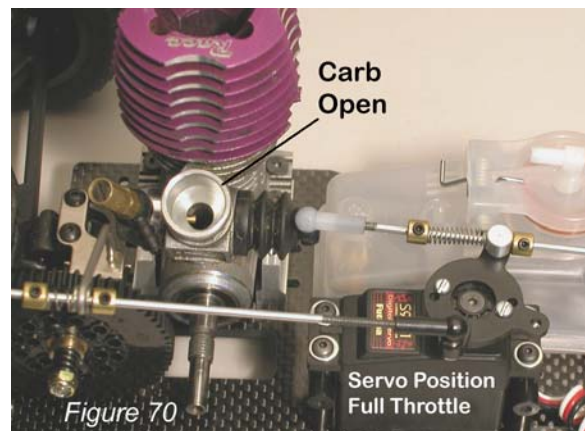

**STEP #10:** Following along with **Figure #71**, adjust the Braking End Point. Notice that at full brake in the picture the spring on the throttle linkage is just about fully compressed. This is about as far as you want to go with the brake travel. However on the track, you may want to trim out even more Braking End Point so that when you stab full brake it does not lock up the tires.

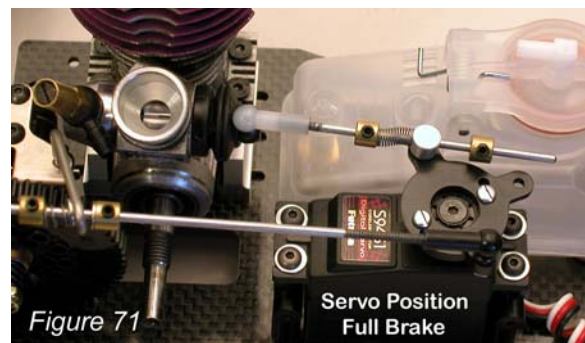

# Bag N Tire and Wheel Installation

**NOTE:** In this step you will be using a fast drying super glue type adhesive to secure the tires and wheels to each other. Be very careful with this process as the glue can tend to run very easily through the tire and may glue your finger to the tire or wheel before you know it. You must follow the directions and precautions provided by the glue manufacturer to insure a secure bond.

**STEP #1:** Using a reamer or the previously used .110" drill bit. Drill a hole in the center of each of the 4 wheels as shown in **Figure 72**.

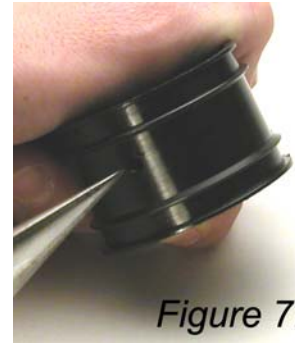

**STEP #2:** If using foam inserts place them inside the tire before mounting on wheels. Now place the wheels inside each of the tires and work both beads of the tire into the channels on the outside edge of the rim. After all 4 tires are completed peel back a portion of the tire from the wheel and apply an even bead of tire glue between the wheel and the tire as shown in **Figure 73**. Repeat this step several times working your way around the tire until it is secure. Now set the wheel and tire down **BUT BE SURE TO PLACE THE FRESHLY GLUED SIDE UP** until it has dried completely. You may repeat this process now for the remaining 3 tires. Once dry it is a good idea to go back and re-seal the edges by applying another small bead of glue and letting it run around the edge of the tire at the gap between tire and wheel.



**STEP #3:** Once the tires have completely dried you may now mount them to the car. Place one #1226 Bearing into each side of the front wheels as shown in **Figure 74**.

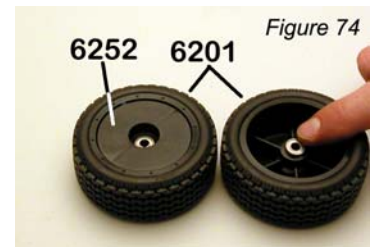

**STEP #4:** Refer to **Figure 75** and place one 3/16" shim over the front axle followed by the front wheel and then another 3/16" shim. Now secure with one 8-32 Locknut, be very careful to not overtighten the nut. you want to tighten it just enough to eliminate any slop from side to side but no more. Repeat for other side of car.



**STEP #5:** Now slide one of the rear wheels onto the rear axle as shown in **Figure 76**. Be sure to index the roll pin in the axle so that it slides into the drive slot molded in the back of the wheel. Now secure with a #5207 locknut. Be sure not to over tighten as you can bend the roll pin.



## Cage and Body Mounting

**Step #1:** Using the longer threaded side of the #5219 Cage Turnbuckle, thread it all the way into one of the #3235 Main Cage Halves. Now thread the other end of the Cage Turnbuckle into the #3233 Rear Bumper by turning the entire Main Cage Half COUNTER-CLOCKWISE to thread the Cage Turnbuckle into the Rear Bumper. The idea is to get both Rear Bumper and Cage Half to tighten against the turnbuckle at the same time regardless of alignment at this point. Now thread the short end of another Cage Turnbuckle into the other side of the Rear Bumper by turning the Cage Turnbuckle COUNTER-CLOCKWISE. Finally thread the remaining Main Cage Half onto the Cage Turnbuckle by turning the entire Cage Half CLOCKWISE. Refer to **Figure #77** for visual.

**Step #2:** Mount the #3233 Real Tail Brace to the Rear Bumper with (1) 5/8" BH Screw as shown in **Figure # 78**.

**Step #3:** Align both Cage Halves so they are parallel to one another and tighten the Cage Turnbuckle if needed. Mount the #3233 Front Bumper by placing (2) 1" SH Screws thru the front of the Main Cage Halves as shown in **Figure #79**.

**Step #4:** Using the (4) Special #5279 3/4" SH Screws with a clip hole drilled in the head, mount the #3235 Upper Cage Brace onto the top of the Cage as shown in **Figure #80**.

**Step #5:** Sub-assemble the remaining parts which are the #3232 Nerf-Bars using (1) 1/2" BH Screw to mount the Nerf Bar Support to the Nerf Bar. Look carefully at **Figure #81** at the Nerf Bar Support and Nerf Bar and you will figure out which one is RIGHT and LEFT from the picture. Before mounting the Nerf Bars you must mount the Body Panels first. We will do this at a later time.

**Step #6:** Mount the Cage to the Chassis by sliding the "hooks" on the front of the cage under the Front Suspension Arms first, then bring the rest of the cage down onto the chassis. Mount those two front hooks with (2) 3/8" FH Screws and the Rear Bumper Brace with (1) 3/8" FH Screw. **Figure #82** shows the Cage mounted to the Chassis.

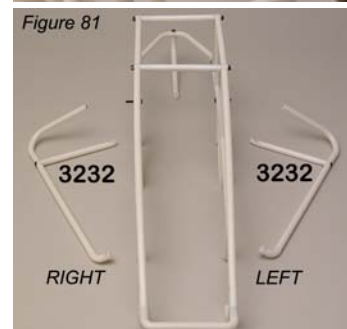
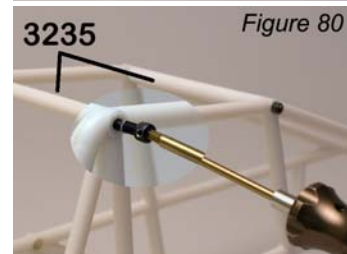
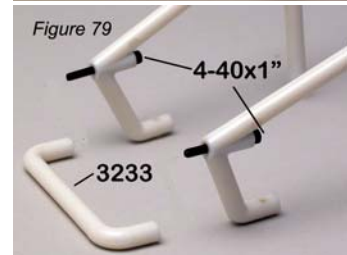
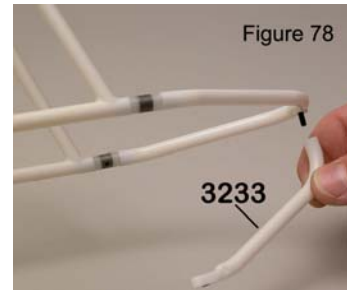
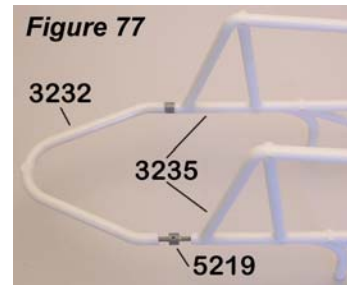

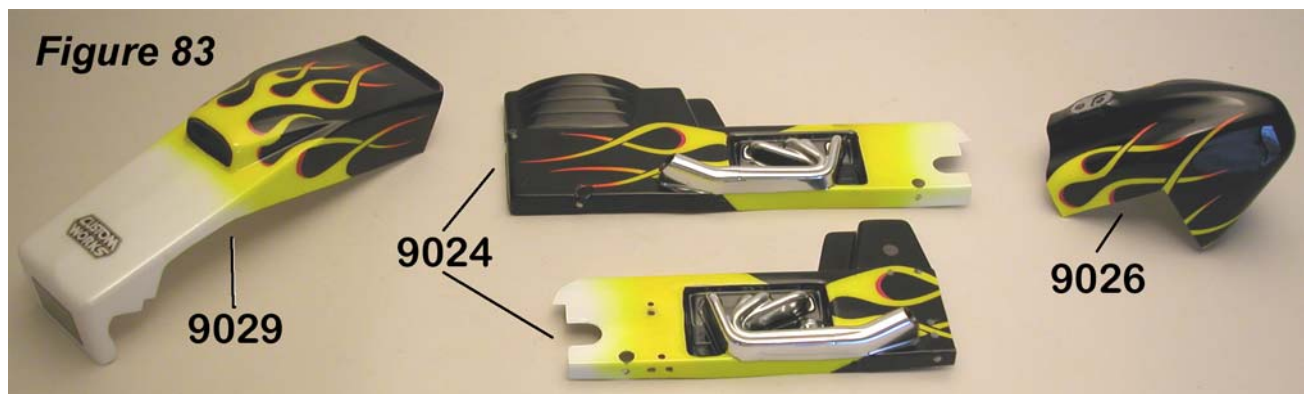

**Step #7:** Using **Figure 83** as a guide and the provided left side panel template, cut the left side #9024 Body Panel to fit the cage. On the right side #9024 Body Panel, #9029 Eagle Hood, #9027 Tail Tank follow the molded body lines.

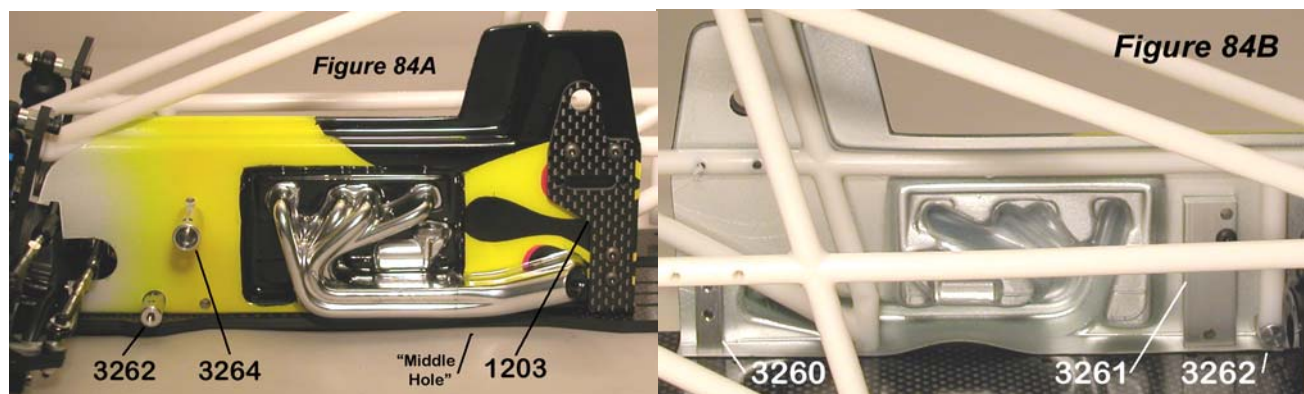

**For Step #8 thru Step #11 follow Figure #84A and 84B.**

**Step #8:** Install the Left Body Panel first by threading (1) 3/8" FH Screw into the Cage thru the chassis and the "middle hole" you made in the bottom of the panel.

**Step #9:** Mount the #3262 Pipe Mount to the chassis using (2) 5/8" FH Screws and (1) Lock Nut. The furthest in-board screw will thread into the cage while the outer screw will pass thru the mount and be secured with a Lock Nut. Use the (1) 3/8" SH Screw in the end of the mount to secure the wire mount that comes off your motor pipe.

**Step #10:** Attach the #3261 Nerf Mount using (2) 3/8" FH Screws directly behind the Pipe Mount on the inside of the Body Panel. Note that the two holes at the top of the Mount face toward the front of the car and should be able to be seen thru the holes you made with the Body Template. Mount the #3264 Nerf Mount Cup to the Mount using (1) 3/8" BH Screw.

**Step #11:** Using (1) 3/8" FH Screw mount the #3260 Cage Mount to the chassis just behind where the Plastic Exhaust ends on the inside of the Body Panel. Then mount the #1203 Front Cage Plate on the outside of the Body Panel to the Cage Mount and Cage using (4) 3/8" BH Screws. Note that the majority of the Cage Plate faces the front of the car.

**Step #12:** Attach (1) #3263 Stand-Off to the chassis using (2) 3/8" FH Screws in the two remaining holes directly in front of the left rear suspension arm as shown in **Figure 85**.

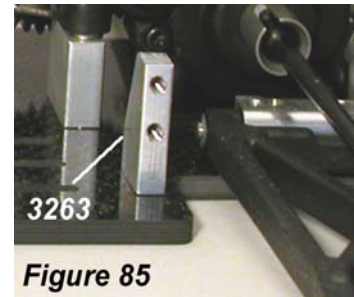

**Step #13:** Using a pair of wire cutters, cut the (2) cage supports directly behind the Front Cage Plate. Then cut the remaining part of the cage directly in front of where the top of the cage comes down to meet the lower portion as shown in **Figure #86**.

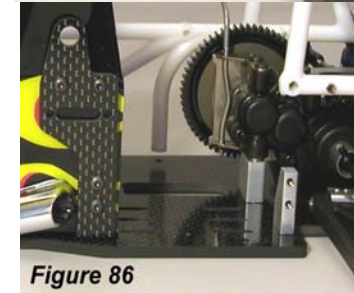

**Step #14:** Using (1) 3/8" BH Screw Mount the Left Side Nerf Bar to the #1204 Rear Cage Plate as shown in **Figure #87**.



**Step #15:** Attach the Rear Cage Plate to the Stand-Off from Step #12 using (2) 3/8" BH Screws. Following **Figure #88** attach the top of the Rear Cage Plate to the Cage using (2) 1/2" BH Screws and Lock Nuts. Secure the front of the Nerf Bar to the Cup using (1) 3/8" BH Screw.

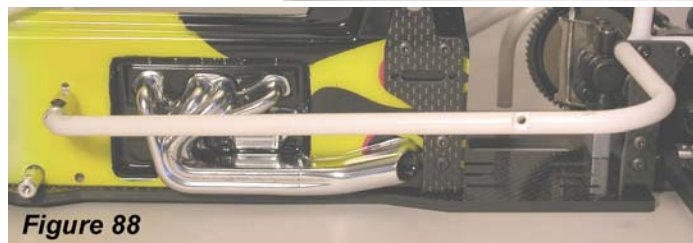

**Step #16:** Fit the #9024 Right Side Body Panel in the same fashion as you did the left side panel. Following along with **Figure #89**, attach the panel first by threading (1) 3/8" FH Screw to the Cage thru the Chassis in the middle hole in the bottom of the Body Panel. Second place the front of the Right Side Nerf Bar thru the hole in the front of the Body Panel. Thread (1) 5/8" FH Screw to the cage as it passes thru the Nerf Bar and Chassis. Next secure the Nerf Bar support in the same fashion as the front of the Nerf Bar using (1) 5/8" FH Screw.

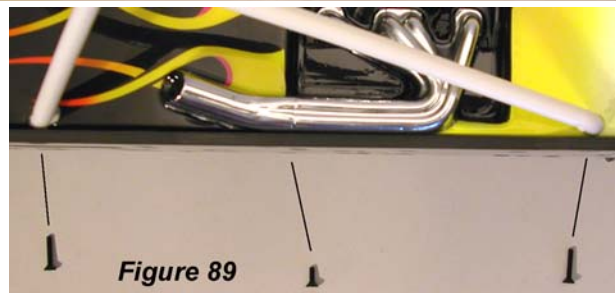

**Step #17:** Secure the top portion of the Nerf Bar to the cage by threading (1) 5/8" BH Screw thru the Cage and into the Nerf Bar as shown in **Figure #90**.



**Step #18:** Mount the "loop" side of the Velcro to the Hood and Tail Tank in the areas shown in **Figure #91**.

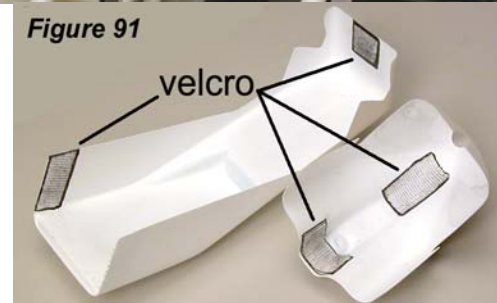

**Step #19:** Following **Figure #92**, mount the “hook” side of the Velcro to the mounts on the car in the places shown. Now you can mount your tail tank and hood.

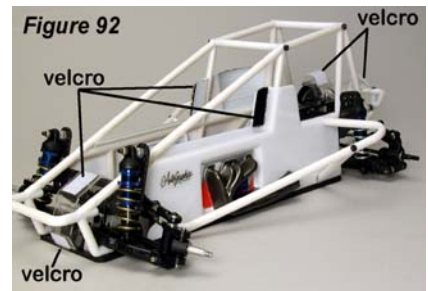

**NOTE:** This kit provides the ability to mount a remote glow igniter that will allow starting of the motor without removing the wing for access to the glow plug. A remote glow igniter can usually be purchased from your local hobby store. The graphite cage support in front of the motor provides a mounting location for the igniter as well as a place to mount your on/off switch if you so desire.



## **Clutch Assembly**

**Step #1:** Slide the #4437 Collet onto the motor shaft followed by the #4430 Flywheel as shown in **Figure #93**.

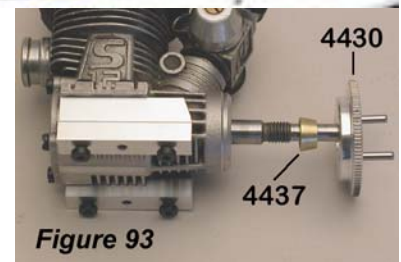

**Step #2:** Secure the Flywheel to the motor using either the #4441 Clutch Nut **OR** #4442 SG Clutch Nut shown in **Figure #94**. Use the #4441 Clutch Nut if your motor has a set of threads in the middle of the shaft. Use the #4442 SG Clutch Nut if your motor shaft ends with external threads. Using either part the end result on the motor should look like **Figure #94**.

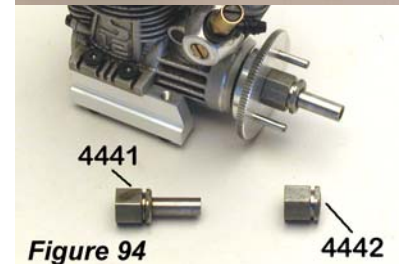

**Step #3:** Place the (2) 4435 Clutch Shoes onto the clutch facing the direction shown in **Figure #95**. Now install the #4431 Clutch Springs onto the Shoes by placing the one leg of the Spring **FIRST** on the Shoe then press the other leg into the groove on the Clutch Nut using a Driver Wrench as shown in **Figure #95**.

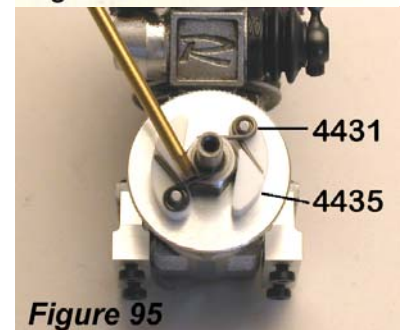

**Step #4:** Following **Figure #96**, slide (1) #4438 Bearing onto the motor shaft followed by the #4440 Clutch Bell. Add the #4439 Flanged Bearing to the front of the Clutch Bell and secure the whole assembly using the (1) 3mm X 6mm SH screw. Thread the #4523 (23T) Pinion onto the Clutch Bell with the side of the pinion with the threads all the way to the edge facing **AWAY** from the motor.

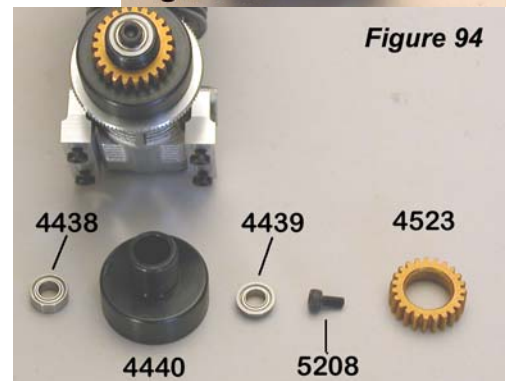

**NOTE:** When the metric screw is tightened, the clutch bell should spin **FREELY**. It is fine to have a small bit of so the Clutch Bell slides back and forth on the motor shaft. If there is too much play use the provided shims to correct this.

## Wing Assembly

Assemble the #9021 Wing Kit using the instructions provided in the Wing Kit. Mount the wing to the car and it should now look just like the car shown below.



**Congratulations!!**

You have now completed the assembly process of your new Custom Works Enforcer GSX kit. In the next section of this manual you will find some basic setup hints and advice. It is important to remember that all tracks and racing surfaces are different. Therefore the suggestions we give you are general in nature and should by no means be treated as the only options.

**TUNING TIPS:** These are some general guidelines for optimizing handling performance. None of these “tips” are EVER set in stone. On any given day this manual or any chassis engineering book or guru can be proved wrong by the almighty stop watch. A good way to approach chassis set-up is to try one change, practice it, think how the car felt different from before, and compare lap times from the stop watch.....this will never fail.

### **Car Pushes (understeers):**

- Decrease Wing Angle
- Decrease Spoiler on Wing
- Heavier Rear Spring
- Softer Front Spring
- Use Rear Sway Bar
- Try Softer Front Compound Tire
- Try Harder Rear Compound Tire
- Lower Front Ride Height
- Raise Rear Ride Height
- Thread Shock Collar UP on Right Front
- Thread Shock Collar DOWN on Right Rear
- Decrease Rear Toe
- Decrease Castor

### **Car Is Loose (oversteers):**

- Increase Wing Angle
- Add Spoiler to Wing
- Softer Rear Spring
- Heavier Front Spring
- Use Front Sway Bar
- Try Harder Front Compound Tire
- Try Softer Rear Compound Tire
- Raise Front Ride Height
- Lower Rear Ride Height
- Thread Shock Collar DOWN on Right Front
- Thread Shock Collar UP on Right Rear
- Increase Rear Toe
- Increase Castor

### **Car Is Erratic:**

- Bent Suspension Pins: Remove shocks to check free movement
- Bound Ball Joint: Should spin free on balls while mounted to the car.
  - Bent or Loose Camber Links
  - Wore out Bearings or Completely Seized Bearings
- Chunked Tire: Check to see if Foam or Rubber Tire is still glued to wheel.
- Loose Screws: Especially Chassis Screws, add Blue Loctite to prevent.
- Shocks: Either Bound-up or Out of Oil. Must swivel freely on mounts.
- Foreign Objects: Unlucky Dirt/Stones preventing Suspension or Steering Movement.
  - Blown Differential
- Radio Problem: Bad Servo, Weak Servo Saver Spring, Transmitter Pot blown.

**Caster:** Angle of the kingpin in relation to a vertical plane as viewed from the side of the car. Increasing the angle will make the car more stable out of the turn and down the straights and increase steering entering a turn. Decreasing the angle will make the car feel more “touchy” at high speeds and help steering while exiting the turn.

**Front Toe IN:** Front edge of car tires point *toward* the chassis as viewed from above the car. Settles and makes steering reaction less aggressive especially on acceleration. Easier set-up to drive and works well for bumpy tracks. **Front Toe OUT:** Front edge of car tires point *away* from the chassis as viewed from above the car. Increases aggressiveness of car especially on entry to the turn. Works well on smooth, high bite tracks where rear traction is not a problem.

**Camber (Front or Rear):** Angle by which the tire and wheel contacts the racing surface when viewed from the Front or Rear of the car. Oval cars generally always have the Right Side tires leaning TOWARD the chassis and the Left Side tires leaning AWAY from the chassis. In oval racing jargon, more camber means more angle TOWARD the chassis on the Right Side and more angle AWAY from the chassis on the Left Side. Starting from 0 Degrees (tire standing straight up) ADDING camber in the oval fashion will increase traction when cornering however remember too much of anything is generally a bad thing. Camber is usually adjusted (especially Foam tires) when one edge of the tire is wearing more than the other.

**Camber Gain:** Angle of the Camber Link relative to the Suspension Arm. Lowering the camber link on the shock tower OR raising the camber link on the castor block will INCREASE the camber angle of the tire when the suspension is compressed. Raising the camber link on the shock tower OR lowering the camber link on the castor block will DECREASE the camber angle of the tire when the suspension is compressed. There is not a “correct” set-up and once again too much of anything is generally bad. This will help change the “feel” of the car thru the turns.

**Camber Link Length:** Comparing this to the length of the Suspension Arm from each pivot point and keeping the Camber the same, making the link *shorter* will decrease traction for that corner of the car while making it *longer* will increase traction for that corner of the car. Once the camber link is equal to or greater than the Suspension Arm pivots, the gain of traction ends. Also a shorter camber link will increase camber gain and a longer decrease camber gain.

**Shock Angle:** Leaning the shock toward the car is effectively like changing to a *softer* spring. Standing the shock closer to vertical is effectively like changing to a *stiffer* spring. Try when the car is working well and when one spring change is TOO much for your set-up.

**Ride Height:** Check by pushing the chassis down once or twice to simulate bumps on the track. Having the front end *higher* than the rear will make the car increase rear traction especially out of the turn. Having the front end *lower* than the front will make the car increase front traction especially entering the turn. Generally its safe to start the car with the ride heights even.

**Rear Toe-In:** Front edge of car tires point *toward* the chassis as viewed from above the car. Increasing the angle toward the car will increase rear traction while decreasing front traction. Decreasing the angle will do the opposite.

**Wheelbase (Front End):** Wheelbase is the distance between the front and rear axles. Running the entire front end assembly in the forward position makes the wheelbase longer and therefore more stable on long/fast tracks with flowing turns. Running the entire front end assembly in the rear position make the wheelbase shorter and therefore more suitable for short-tracks where you are constantly turning.

**Wheelbase (Rear End):** This adjustment uses the plastic spacers on the kingpin the rear bearing carrier rides on. With the spacers in front of the carrier it will lengthen the wheelbase but will increase steering. If the spacers are behind the carrier it will shorten the wheelbase but increase rear traction. This is completely backwards from how it works for the Front End only because in the rear of the car you have the weight of the motor and the torque it creates. Shortening the wheelbase here makes more of the car hang over the rear tires and promotes more weight transfer.

**Final Drive Chart:** The chart provided below gives you the final drive of the motor to spin the axle 1 revolution. This chart is NOT just the pinion and spur, but has the transmission ratio included as well.

To determine the final drive in your car:

- 1) Divide the Spur Gear by the Pinion Gear, which equals a "Ratio".
- 2) Multiply the "Ratio" by the "Transmission Ratio", which will equal your "Final Drive".

**Final Drive Ratio Chart**

Transmission Ratio 2.60

Pinion	Spur Gear							
	54	56	58	60	62	64	66	68
12	11.70	12.13	12.57	13.00	13.43	13.87	14.30	14.73
13	10.80	11.20	11.60	12.00	12.40	12.80	13.20	13.60
14	10.03	10.40	10.77	11.14	11.51	11.89	12.26	12.63
15	9.36	9.71	10.05	10.40	10.75	11.09	11.44	11.79
16	8.78	9.10	9.43	9.75	10.08	10.40	10.73	11.05
17	8.26	8.56	8.87	9.18	9.48	9.79	10.09	10.40
18	7.80	8.09	8.38	8.67	8.96	9.24	9.53	9.82
19	7.39	7.66	7.94	8.21	8.48	8.76	9.03	9.31
20	7.02	7.28	7.54	7.80	8.06	8.32	8.58	8.84
21	6.69	6.93	7.18	7.43	7.68	7.92	8.17	8.42
22	6.38	6.62	6.85	7.09	7.33	7.56	7.80	8.04
23	6.10	6.33	6.56	6.78	7.01	7.23	7.46	7.69
24	5.85	6.07	6.28	6.50	6.72	6.93	7.15	7.37
25	5.62	5.82	6.03	6.24	6.45	6.66	6.86	7.07
26	5.40	5.60	5.80	6.00	6.20	6.40	6.60	6.80
27	5.20	5.39	5.59	5.78	5.97	6.16	6.36	6.55
28	5.01	5.20	5.39	5.57	5.76	5.94	6.13	6.31
29	4.84	5.02	5.20	5.38	5.56	5.74	5.92	6.10
30	4.68	4.85	5.03	5.20	5.37	5.55	5.72	5.89
31	4.53	4.70	4.86	5.03	5.20	5.37	5.54	5.70
32	4.39	4.55	4.71	4.88	5.04	5.20	5.36	5.53
33	4.25	4.41	4.57	4.73	4.88	5.04	5.20	5.36
34	4.13	4.28	4.44	4.59	4.74	4.89	5.05	5.20
35	4.01	4.16	4.31	4.46	4.61	4.75	4.90	5.05



Custom Works RC Products, LLC.  
 760-B Crosspoint Drive  
 Denver, NC 28037  
 (704)489-8147 phone  
 (704)489-0488 fax  
 www.CustomWorksRC.com

Jan. 2005 PRICE LIST

Part#	Description	Price
0927	Enforcer GSX Kit	\$ 695.00
1201	Enforcer GSX Chassis	\$ 100.00
1202	GSX Transmission Spacer	\$ 5.00
1203	Enforcer GSX Front Cage Support	\$ 7.50
1204	Enforcer GSX Rear Cage Support	\$ 6.50
1226	Bearings 3/16" X 3/8" (2)	\$ 12.00
1229	5/32x5/16 bearings (2)	\$ 13.00
1230	3/8x5/8 bearings (2)	\$ 8.00
1242	Enforcer GSX Front Shock Tower	\$ 20.00
1243	Enforcer GSX Rear Shock Tower	\$ 22.00
1244	Enforcer GSX Transmission Brace	\$ 7.00
1248	GX Series Rear Arm Spacers	\$ 4.00
1250	Silicone O-Rings (8)	\$ 2.50
1400	GX Threaded Shock Set (pr)	\$ 30.00
1401	Threaded Shock Body (pr)	\$ 14.00
1402	Threaded Shock Collar	\$ 4.00
1403	Threaded Collar O-ring (4)	\$ 4.00
1404	Plastic Shock Cap	\$ 2.50
1405	Shock Piston Set	\$ 3.00
1406	Shock Cap O-ring	\$ 2.00
1407	Shock Spring Cups (4)	\$ 5.00
1408	Shock Bushings (4)	\$ 1.00
1409	Shock Eyelet and Pivot Ball (2)	\$ 3.00
1411	GX Shock Rebuild Kit (4)	\$ 4.00
1413	Shock Shaft .35	\$ 3.00
1442	GX Silver Spring 14.5 lb. (pair)	\$ 3.00
1444	GX Gold Spring 19.5 lb. (pair)	\$ 3.00
2204	Front Suspension Mount	\$ 19.00
2211	Suspension Mount Brace	\$ 6.00
2214	Shock Standoff (2)	\$ 4.00
2218	Camber Link Standoff (2)	\$ 11.00
2222	Rear Toe-Block 1-3 degree (2)	\$ 29.00
2224	GBX Top Plate Block	\$ 9.00
3202	Front Steering Block (pair)	\$ 4.00
3203	25 Degree Caster Block (pair)	\$ 5.00
3207	Steering Rack Assembly	\$ 9.00
3209	Antenna Kit	\$ 2.00
3232	Nerf Bar Set	\$ 18.00
3233	Bumper Set front & rear	\$ 10.00
3235	GX Main Cage Parts	\$ 28.00
3240	Rear A-Arms GX Series (pair)	\$ 7.00
3241	Rear Axle Carrier GX Series (pair)	\$ 7.00
3250	Front Suspension Arm (pair)	\$ 10.00
3260	GSX Front Cage Mount	\$ 10.00
3261	GSX Front Nerf Bar Mount	\$ 13.00
3262	GSX Pipe Mount	\$ 9.00
3263	GSX Rear Tower Mount	\$ 10.00
3264	GSX Nerf Mount Cup	\$ 8.00
3265	GSX Transmission Support	\$ 5.00
3270	GSX Motor Mounts	\$ 25.00

Part#	Description	Price
4233	Inner Front Suspension Pin (4)	\$ 7.00
4234	GBX Inner Rear Suspension Pin (2)	\$ 4.00
4235	GBX Outer Rear Suspension Pin	\$ 4.00
4236	Rear Carrier Shims	\$ 3.00
4237	Outer Front Suspension Pin (2)	\$ 4.00
4357	Carbide Diff Balls (12)	\$ 12.00
4359	Diff Thrust Balls 5/64" (6)	\$ 2.00
4360	Diff Thrust Washers (2)	\$ 3.00
4361	Diff Thrust Bolt, Cover and T-nut	\$ 2.00
4362	Diff Spring	\$ 2.00
4368	GX Series Top Drive Shaft	\$ 9.00
4370	Top Shaft Shim Set (6)	\$ 2.00
4371	Inner Torque Clutch Hub	\$ 7.50
4372	Outer Torque Clutch Hub	\$ 7.50
4373	Clutch Disc	\$ 3.00
4374	Torque Control Spring & Nut	\$ 2.00
4375	Thrust Bearing (3)	\$ 2.00
4376	3/16x3/8 Bushing (2)	\$ 2.00
4388	Black Grease	\$ 2.50
4391	Diff Lube	\$ 2.50
4400	Complete Transmission	\$ 120.00
4401	GSX Transmission Case	\$ 7.00
4402	GSX Left Diff Outdrive Hub	\$ 7.50
4403	GSX Right Diff Outdrive Hub	\$ 7.50
4404	Diff Rings for GSX	\$ 2.00
4405	GSX Idler Gear w/shaft	\$ 5.00
4406	GSX Top Shaft Roll Pin	\$ 1.00
4407	GSX Diff Gear	\$ 2.50
4408	Differential Assembly	\$ 39.00
4420	GSX Brake Bracket	\$ 3.00
4421	GSX Brake Shoe	\$ 2.00
4422	GSX Disk Brake Cam Lever	\$ 3.00
4423	GSX Composite Brake Disk	\$ 4.00
4424	GSX Disk Brake Adapter	\$ 4.00
4425	GSX Brake Cam Clip (6)	\$ 2.00
4430	GSX Flywheel	\$ 8.00
4431	GSX Clutch Spring (pr)	\$ 2.00
4432	GSX Clutch Spring Heavy (pr)	\$ 2.00
4435	GSX Clutch Shoes (pr)	\$ 5.00
4437	GSX Flywheel Collet	\$ 3.50
4438	GSX Clutch Bearing	\$ 6.00
4439	GSX Flanged Clutch Bearing	\$ 5.00
4440	GSX Clutch Bell	\$ 6.50
4441	Clutch Nut Adapter	\$ 5.00
4442	Clutch Nut for SG Crank	\$ 3.50
4450	GSX Fuel Tank	\$ 14.00
4523	GSX 23 Tooth Pinion (gold)	\$ 6.50
4960	60T 32P GSX Spur Gear	\$ 5.00
5201	Screw Pack 2-56 Assorted	\$ 3.50
5202	Screw Pack 4-40 Assorted	\$ 5.50

**Sept. 2004 PRICE LIST**

**Continued**

Part#	Description	Price
5203	Small E-Clip front	\$ 4.00
5204	Aluminum Locknut 2-56 (10)	\$ 5.00
5205	Aluminum Locknut 4-40 (10)	\$ 5.00
5207	Steel Locknut 8-32	\$ 2.00
5208	Motor Screws 3x6mm	\$ 3.00
5210	#2 Flat Washer (20)	\$ 2.00
5212	#4 Flat Washer (20)	\$ 2.00
5213	Camber Link Ball End long (4)	\$ 5.50
5214	Ball End for Tie Rod	\$ 3.50
5219	Cage Turnbuckle (2)	\$ 8.00
5221	Titanium Turnbuckle .900" (2)	\$ 10.00
5222	Titanium Turnbuckle 1.500" (2)	\$ 10.00
5223	Titanium Turnbuckle 1.750" (2)	\$ 10.00
5228	Camber Link Ball End short (4)	\$ 5.50
5229	Short Ball End 2-56 ball (4)	\$ 3.50
5230	1/8" E-Clip	\$ 2.00
5240	Servo Mounts	\$ 2.50
5242	Servo Saver	\$ 7.00
5245	5-40 Locknut for Slipper	\$ 2.00
5246	GSX Brake/Throttle Linkage Kit	\$ 9.00
6201	Sticker Tire front (2)	\$ 12.00
6211	Sticker Tire rear (2)	\$ 13.00
6252	Front Wheel for rubber tire	\$ 8.50
6253	Rear Wheel for rubber tire	\$ 8.50
7047	Shims Assorted	\$ 5.00
7201	Front Axle	\$ 7.50
7202	Front King Pin (2)	\$ 3.00
7204	Drive Pin for Rear Axle (10)	\$ 2.00
7212	GSX CVD Drive System Std. (pair)	\$ 30.00
9021	Enforcer Wing Kit	\$ 34.00
9024	Enforcer Body Side Panels (pair)	\$ 16.00
9027	Enforcer GBX Tail Tank w/mount	\$ 9.00
9029	Eagle Sprint Hood	\$ 12.00
9035	Enforcer GBX Body Complete	\$ 30.00
9036	Wing Hitch Pins (8)	\$ 2.00
9903	Self-Stick Velcro	\$ 2.00

Part#	Optional Parts & Miscellaneous	Price
2221	Rear Toe-Block 0-2 degree (2)	\$ 29.00
3204	Front Caster Blocks 20 degree (pr)	\$ 5.00
3205	Front Caster Blocks 15 degree (pr)	\$ 5.00
4520	GSX 20 Tooth Pinion (silver)	\$ 6.50
4521	GSX 21 Tooth Pinion (gray)	\$ 6.50
4522	GSX 22 Tooth Pinion (blue)	\$ 6.50
4524	GSX 24 Tooth Pinion (red)	\$ 6.50
4525	GSX 25 Tooth Pinion (green)	\$ 6.50
4526	GSX 26 Tooth Pinion (black)	\$ 6.50
4527	GSX 27 Tooth Pinion (purple)	\$ 6.50
7208	Rear Wheel Spacers .125" (2)	\$ 14.00
7209	On-Center King Pin Kit	\$ 7.00
9022	Speedway Sprint Hood	\$ 11.00
9028	Enforcer Wing Mounts	\$ 5.00
9031	Upper Cage Side Panels	\$ 5.00
9032	Wing and Side Panel Brace	\$ 3.00
9033	Sprint Wing Side Panels	\$ 8.00

Part#	Optional Shock Springs	Price
1440	GX Spring Assortment (9 pair)	\$ 34.00
1441	GX Green Spring 12.0 lb. (pair)	\$ 5.00
1443	GX Blue Spring 17.0 lb. (pair)	\$ 5.00
1445	GX Red Spring 22.0 lb. (pair)	\$ 5.00
1446	GX Copper Spring 25.0 lb. (pair)	\$ 5.00
1452	GX Purple Spring 30.0 lb. (pair)	\$ 5.00
1453	GX Yellow Spring 35.0 lb. (pair)	\$ 5.00
1454	GX White Spring 40.0 lb. (pair)	\$ 5.00

Part#	Hardware	Price
5004	Set Screw 6-32 (10)	\$ 2.00
5250	4-40x3/16" Button Head (6)	\$ 2.00
5252	4-40x1/4" Button Head Screw (8)	\$ 2.00
5253	4-40x3/8" Button Head Screw (8)	\$ 2.00
5254	4-40x1/2" Button Head Screw (8)	\$ 2.00
5255	4-40x5/8" Button Head Screw (8)	\$ 2.00
5262	4-40x1/4" Flat Head Screw (8)	\$ 2.00
5263	4-40x3/8" Flat Head Screw (8)	\$ 2.00
5264	4-40x1/2" Flat Head Screw (8)	\$ 2.00
5265	4-40x5/8" Flat Head Screw (8)	\$ 2.00
5274	4-40x1/2" Socket Head Screw (4)	\$ 2.00
5275	4-40x5/8" Socket Head Screw (4)	\$ 2.00
5277	4-40x7/8" Socket Head Screw (4)	\$ 2.00
5278	4-40x1" Socket Head Screw (4)	\$ 2.00
5279	4-40x3/4 Socket w/hole (wing)	\$ 7.00

Part#	Optional Tires and Wheels	Price
6204	Street Trac Tire front (2)	\$ 12.00
6213	Qualifier Tire rear (2)	\$ 13.00
6214	Street Trac Tire rear (2)	\$ 13.00
6250	Front Wheels for Foam Tires (2)	\$ 7.00
6251	Rear Wheels for Foam Tires (2)	\$ 7.00
6270	Silver Foam front (2)	\$ 23.50
6271	Pink Foam front (2)	\$ 27.50
6272	Purple Foam front (2)	\$ 27.50
6273	Gray Foam front (2)	\$ 26.00
6274	Black Foam front (2)	\$ 26.00
6275	Green Foam front (2)	\$ 23.00
6280	Silver Foam rear (2)	\$ 26.50
6281	Pink Foam rear (2)	\$ 34.50
6282	Purple Foam rear (2)	\$ 34.50
6283	Gray Foam rear (2)	\$ 34.00
6284	Black Foam rear (2)	\$ 34.00
6285	Green Foam rear (2)	\$ 25.00

Part#	T-Shirts and Sweatshirts	Price
1500M	Custom Works T-Shirt (M)	\$ 18.00
1500L	Custom Works T-Shirt (L)	\$ 18.00
1500XL	Custom Works T-Shirt (XL)	\$ 18.00
1500XXL	Custom Works T-Shirt (XXL)	\$ 20.00
1500XXXL	Custom Works T-Shirt (XXXL)	\$ 20.00
1600M	Custom Works Sweat Shirt (M)	\$ 25.00
1600L	Custom Works Sweat Shirt (L)	\$ 25.00
1600XL	Custom Works Sweat Shirt (XL)	\$ 25.00
1600XXL	Custom Works Sweat Shirt (XXL)	\$ 28.00
1600XXXL	Custom Works Sweat Shirt (XXXL)	\$ 28.00